

OECD GUIDELINE FOR THE TESTING OF CHEMICALS

Acute Inhalation Toxicity - Acute Toxic Class Method

INTRODUCTION

1. OECD Guidelines for the Testing of Chemicals are periodically reviewed in the light of scientific progress, changing regulatory needs and animal welfare considerations. The first acute inhalation Test Guideline 403 was adopted in 1981, and has since been revised (1). Development of an Inhalation Acute Toxic Class (ATC) method (2) (3) (4) was considered appropriate following the adoption of the revised oral ATC method (TG 423) (5) in 2001. A retrospective performance assessment of the ATC test method for acute inhalation toxicity showed that the method is suitable for being used for Classification and Labelling purposes (6). The inhalation ATC Test Guideline will allow the use of serial steps of fixed target concentrations to provide a ranking of test article toxicity. Lethality is used as key endpoint, however, animals in severe pain or distress, suffering or impending death should be humanely killed to minimize suffering. Guidance on humane endpoints is available in the OECD Guidance Document No. 19 (7).
2. Guidance on the conduct and interpretation of this Test Guideline can be found in the Guidance Document No. 39 on Acute Inhalation Toxicity Testing (GD 39) (8).
3. Definitions used in the context of this Guideline are provided in GD 39 (8).
4. The method provides information on the hazardous properties and allows the substance to be ranked and classified according to the United Nations (UN) Globally Harmonized System of Classification and Labelling of Chemicals (GHS) for the classification of chemicals that cause acute toxicity (9). In case point estimates of LC₅₀-values or concentration-response analyses are required, Test Guideline 403 (1) is the appropriate Test Guideline to use. Further guidance on Test Guideline selection can be found in GD 39 (8). This Test Guideline is not specifically intended for the testing of specialized materials, such as poorly soluble isometric or fibrous materials or manufactured nanomaterials.

INITIAL CONSIDERATIONS

5. Before considering testing in accordance with this Test Guideline all available information on the test article, including existing studies whose data would support not doing additional testing should be considered by the testing laboratory in order to minimize animal usage. Information that may assist in the selection of the most appropriate species, strain, sex, mode of exposure and appropriate test concentrations include the identity, chemical structure, and physico-chemical properties of the test article; results of any *in vitro* or *in vivo* toxicity tests; anticipated use(s) and potential for human exposure; available (Q)SAR data and toxicological data on structurally related

© OECD, (2009)

You are free to use this material for personal, non-commercial purposes without seeking prior consent from the OECD, provided the source is duly mentioned. Any commercial use of this material is subject to written permission from the OECD.

substances. Concentrations that are expected to cause severe pain and distress, due to corrosive¹ or severely irritant actions, should not be tested with this Test Guideline [see GD 39 (8)].

PRINCIPLE OF THE TEST

6. It is the principle of the test that based on a stepwise procedure, sufficient information is obtained on the acute inhalation toxicity of the test article during an exposure period of 4 hours to enable its classification. Other durations of exposure may apply to serve specific regulatory purposes. At any of the defined concentration steps, 3 animals of each sex are tested. Depending on the mortality and/or the moribund status of the animals, 2 steps may be sufficient to allow judgement on the acute toxicity of the test article. If evidence is provided that one sex is more susceptible than the other, then the test may be continued with the more susceptible sex only. The outcome of the previous step will determine the following step such that:

- a) No further testing is needed,
- b) Testing of three animals per sex, or
- c) Testing with 6 animals of the more susceptible sex only *i.e.* the lower boundary estimates of the toxic class should be based on 6 animals per test concentration group, regardless of sex.

7. Moribund animals or animals obviously in pain or showing signs of severe and enduring distress should be humanely killed, and are considered in the interpretation of the test results in the same way as animals that died on test. Criteria for making the decision to kill moribund or severely suffering animals, and guidance on the recognition of predictable or impending death, are the subject of Guidance Document No. 19 on Humane Endpoints (7).

DESCRIPTION OF THE METHOD

Selection of animal species

8. Healthy young adult animals of commonly used laboratory strains should be used. The preferred species is the rat and justifications should be provided if other species are used.

Preparation of animals

9. Females should be nulliparous and non-pregnant. On the exposure day, animals should be young adults 8 to 12 weeks of age, and body weights should be within $\pm 20\%$ of the mean weight for each sex of any previously exposed animals at the same age. The animals are randomly selected, marked for individual identification. The animals are kept in their cages for at least 5 days prior to the start of the test to allow for acclimatization to laboratory conditions. Animals should also be acclimatised to the test apparatus for a short period prior to testing, as this will lessen the stress caused by introduction to the new environment.

Animal husbandry

10. The temperature of the experimental animal maintenance room should be $22\pm 3^\circ\text{C}$. The relative humidity should ideally be maintained in the range of 30 to 70%, though this may not be

¹ The corrosivity evaluation could be based on expert judgment using such evidence as: human and animal experience, existing (*in vitro*) data, *e.g.* TGs 430 (10), 431 (11) or 435 (12), pH values, information from similar substances or any other pertinent data.

possible when using water as a vehicle. Before and after exposures, animals generally should be caged in groups by sex and concentration, but the number of animals per cage should not interfere with clear observation of each animal and should minimize losses due to cannibalism and fighting. When animals are to be exposed nose-only, it may be necessary for them to be acclimated to the restraining tubes. The restraining tubes should not impose undue physical, thermal, or immobilization stress on the animals. Restraint may affect physiological endpoints such as body temperature (hyperthermia) and/or respiratory minute volume. If generic data are available to show that no such changes occur to any appreciable extent, then pre-adaptation to the restraining tubes is not necessary. Animals exposed whole-body to an aerosol should be housed individually during exposure to prevent them from filtering the test aerosol through the fur of their cage mates. Conventional and certified laboratory diets may be used, except during exposure, accompanied with an unlimited supply of municipal drinking water. Lighting should be artificial, the sequence being 12 hours light/12 hours dark.

Inhalation chambers

11. The nature of the test article and the objective of the test should be considered when selecting an inhalation chamber. The preferred mode of exposure is nose-only (which term includes head-only, nose-only or snout-only). Nose-only exposure is generally preferred for studies of liquid or solid aerosols and for vapours that may condense to form aerosols. Special objectives of the study may be better achieved by using a whole-body mode of exposure, but this should be justified in the study report. To ensure atmosphere stability when using a whole-body chamber, the total volume of the test animals should not exceed 5% of the chamber volume. Principles of the nose-only and whole body exposure techniques and their particular advantages and disadvantages are described in GD 39 (8).

EXPOSURE CONDITIONS

Administrations of concentrations

12. A fixed duration of exposure for four hours, excluding equilibration time, is recommended. Other durations may be needed to meet specific requirements, however, justification should be provided in the study report [see GD 39 (8)]. Animals exposed in whole-body chambers should be housed individually to prevent ingestion of test article due to grooming of cage mates. Feed should be withheld during the exposure period. Water may be provided throughout a whole-body exposure.

13. Animals are exposed to the test article as a gas, vapour, aerosol, or a mixture thereof. The physical state to be tested depends on the physico-chemical properties of the test article, the selected concentration, and/or the physical form most likely present during the handling and use of the test article. Hygroscopic and chemically reactive test articles should be tested under dry air conditions. Care should be taken to avoid generating explosive concentrations.

Particle-size distribution

14. Particle sizing should be performed for all aerosols and for vapours that may condense to form aerosols. To allow for exposure of all relevant regions of the respiratory tract, aerosols with mass median aerodynamic diameters (MMAD) ranging from 1 to 4 μm with a geometric standard deviation (σ_g) in the range of 1.5 to 3.0 are recommended (8) (13) (14). Although a reasonable effort should be made to meet this standard, expert judgment should be provided if it cannot be achieved. For example, metal fumes may be smaller than this standard, and charged particles, fibres, and hygroscopic materials (which increase in size in the moist environment of the respiratory tract) may exceed this standard.

Test article preparation in a vehicle

15. A vehicle may be used to generate an appropriate concentration and particle size of the test article in the atmosphere. As a rule, water should be given preference. Particulate material may be subjected to mechanical processes to achieve the required particle size distribution, however, care should be taken not to decompose or alter the test article. In cases where mechanical processes are believed to have altered test article composition (*e.g.* extreme temperature from excessive milling due to friction), the composition of the test article should be verified analytically. Adequate care should be taken to not contaminate the test material. It is not necessary to test non-friable granular materials which are purposefully formulated to be un-inhalable. An attrition test should be used to demonstrate that respirable particles are not produced when the granular material is handled. If an attrition test produces respirable articles, an inhalation toxicity test should be performed.

Control animals

16. A concurrent negative (air) control group is not necessary. When a vehicle other than water is used to assist in generating the test atmosphere, a vehicle control group should only be used when historical inhalation toxicity data are not available. If a toxicity study of a test article formulated in a vehicle reveals no toxicity, it follows that the vehicle is non-toxic at the concentration tested; thus, there is no need for a vehicle control.

MONITORING OF EXPOSURE CONDITIONS***Chamber airflow***

17. The flow of air through the chamber should be carefully controlled, continuously monitored, and recorded at least hourly during each exposure. The monitoring of test atmosphere concentration (or stability) is an integral measurement of all dynamic parameters and provides an indirect means to control all relevant dynamic atmosphere generation parameters. Special consideration should be given to avoiding re-breathing in nose-only chambers in cases where airflow through the exposure system are inadequate to provide dynamic flow of test article atmosphere. There are prescribed methodologies that can be used to demonstrate that re-breathing does not occur under the selected operation conditions (8) (15). Oxygen concentration should be at least 19% and carbon dioxide concentration should not exceed 1%. If there is reason to believe that these standards cannot be met, oxygen and carbon dioxide concentrations should be measured.

Chamber temperature and relative humidity

18. Chamber temperature should be maintained at $22\pm 3^{\circ}\text{C}$. Relative humidity in the animals' breathing zone, for both nose-only and whole-body exposures, should be monitored and recorded at least three times for durations up to 4 hrs, and hourly for shorter durations. The relative humidity should ideally be maintained in the range of 30 to 70%, but this may either be unattainable (*e.g.* when testing water based formulations) or not measurable due to test article interference with the test method.

Test article: nominal concentration

19. Whenever feasible, the nominal exposure chamber concentration should be calculated and recorded. The nominal concentration is the mass of generated test article divided by the total volume of air passed through the chamber system. The nominal concentration is not used to characterize the

animals' exposure, but a comparison of the nominal and the actual concentration gives an indication of the generation efficiency of the test system, and thus may be used to discover generation problems.

Test article: actual concentration

20. The actual concentration is the test article concentration at the animals' breathing zone in an inhalation chamber. Actual concentrations can be obtained either by specific methods (*e.g.* direct sampling, adsorptive or chemical reactive methods, and subsequent analytical characterisation) or by non-specific methods such as gravimetric filter analysis. The use of gravimetric analysis is acceptable only for single component powder aerosols or aerosols of low volatility liquids and should be supported by appropriate pre-study test article-specific characterisations. Multi-component powder aerosol concentration may also be determined by gravimetric analysis. However, this requires analytical data which demonstrate that the composition of airborne material is similar to the starting material. If this information is not available, a reanalysis of the test material (ideally in its airborne state) at regular intervals during the course of the study may be necessary. For aerosolised agents that may evaporate or sublime, it should be shown that all phases were collected by the method chosen. The target, nominal, and actual concentrations should be provided in the study report, but only actual concentrations are used in statistical analyses to calculate lethal concentration values.

21. One lot of the test article should be used, if possible, and the test sample should be stored under conditions that maintain its purity, homogeneity, and stability. Prior to the start of the study, there should be a characterization of the test article, including its purity and, if technically feasible, the identity, and quantities of identified contaminants and impurities. This can be demonstrated by, but is not limited to, the following data: retention time and relative peak area, molecular weight from mass spectroscopy or gas chromatography analyses, or other estimates. Although the test sample's identity is not the responsibility of the test laboratory, it may be prudent for the test laboratory to confirm the sponsor's characterization at least in a limited way (*e.g.* colour, physical nature, etc.).

22. The exposure atmosphere shall be held as constant as practicable and monitored continuously and/or intermittently depending on the method of analysis. When intermittent sampling is used, chamber atmosphere samples should be taken at least twice in a four hour study. If not feasible due to limited air flow rates or low concentrations, one sample may be collected over the entire exposure period. If marked sample-to-sample fluctuations occur, the next concentrations tested should use four samples per exposure. Individual chamber concentration samples should not deviate from the mean chamber concentration by more than $\pm 10\%$ for gases and vapours, and by no more than $\pm 20\%$ for liquid or solid aerosols. Time to chamber equilibration (t_{95}) should be calculated and recorded. The duration of an exposure spans the time that the test article is generated and this takes into account the times required to attain t_{95} . Guidance for estimating t_{95} can be found in GD 39 (8).

23. For very complex mixtures consisting of vapours/gases, and aerosols (*e.g.* combustion atmospheres and test articles propelled from purpose-driven end-use products/devices), each phase may behave differently in an inhalation chamber so at least one indicator substance (analyte), normally the principal active substance in the tested product formulation, of each phase (vapour/gas and aerosol) should be selected. When the test article is a mixture (*e.g.* a formulation), the analytical concentration should be reported for the total formulation and not just for the active ingredient or the component (analyte). Additional information regarding actual concentrations can be found in GD 39 (8).

Test article: particle size distribution

24. The particle size distribution of aerosols should be determined at least twice during each 4 hour exposure by using a cascade impactor or an alternative instrument such as an aerodynamic particle sizer. If equivalence of the results obtained by a cascade impactor or an alternative instrument

can be shown, then the alternative instrument may be used throughout the study. A second device, such as a gravimetric filter or an impinger/gas bubbler, should be used in parallel to the primary instrument to confirm the collection efficiency of the primary instrument. The mass concentration obtained by particle size analysis should be within reasonable limits of the mass concentration obtained by filter analysis [see GD 39 (8)]. If equivalence can be demonstrated in the early phase of the study, then further confirmatory measurements may be omitted. For animal welfare reasons, measures should be taken to minimize inconclusive data which may lead to a need to repeat an exposure. Particle sizing should be performed for vapours if there is any possibility that vapour condensation may result in the formation of an aerosol, or if particles are detected in a vapour atmosphere with potential for mixed phases (see paragraph 14).

PROCEDURE

Main test

26. Three animals per sex, or six animals of the more susceptible sex, are used for each step. If rodent species other than rats are exposed nose-only, maximum exposure durations may be adjusted to minimise species-specific distress. The concentration level to be used as the starting dose is selected from one of four fixed levels and the starting concentration level should be that which is most likely to produce toxicity in some of the dosed animals. The testing schemes for gases, vapours and aerosols (included in Annexes 1-3) represent the testing with the cut-off values of the GHS categories 1-4 (9) for gases (100, 500, 2500, 20000 ppm/4h) (Annex 1), for vapours (0.5, 2, 10, 20 mg/L/4h) (Annex 2) and for aerosols (0.05, 0.5, 1, 5 mg/L/4h) (Annex 3). Category 5 relates to concentrations above the respective limit concentrations. For each starting concentration, the respective testing scheme applies. Depending on the number of humanely killed or dead animals, the test procedure follows the indicated arrows until a categorisation can be made.

26. The time interval between exposure groups is determined by the onset, duration, and severity of toxic signs. Exposure of animals at the next concentration level should be delayed until there is reasonable confidence in the survival of the previously tested animals. A period of three or four days between the exposures at each concentration level is recommended to allow for the observation of delayed toxicity. The time interval may be adjusted as appropriate, *e.g.* in case of inconclusive responses.

Limit test

27. The limit test is used when the test article is known or expected to be virtually non-toxic, *i.e.* eliciting a toxic response only above the regulatory limit concentration. Information about the toxicity of the test material can be gained from knowledge about similar tested compounds or similar tested mixtures or products, taking into consideration the identity and percentage of components known to be of toxicological significance. In those situations where there is little or no information about its toxicity, or the test material is expected to be toxic, the main test should be performed [further guidance can be found in GD 39 (8)].

28. Using the normal procedure, three animals per sex, or six animals of the more susceptible sex, are exposed at concentrations of 20000 ppm for gases, 20 mg/L for vapours and 5 mg/L for dusts/mists, respectively (if achievable), which serves as the limit test for this Test Guideline. When testing aerosols, the primary goal should be to achieve a respirable particle size (*i.e.* an MMAD of 1-4 µm). This is possible with most test articles at a concentration of 2 mg/L. Aerosol testing at greater than 2 mg/L should only be attempted if a respirable particle size can be achieved [see GD 39 (8)]. GHS discourages testing in excess of a limit concentration for animal welfare reasons (9). Testing in

GHS Category 5 should only be considered when there is a strong likelihood that results of such a test would have direct relevance for protecting human health (9), and justification provided in the study report. In the case of potentially explosive test articles, care should be taken to avoid conditions favourable for an explosion. To avoid an unnecessary use of animals, a test run without animals should be conducted prior to the limit test to ensure that the chamber conditions for a limit test can be achieved.

Observations

29. The animals should be clinically observed frequently during the exposure period. Following exposure, clinical observations should be made at least twice on the day of exposure, or more frequently when indicated by the response of the animals to treatment, and at least once daily thereafter for a total of 14 days. The length of the observation period is not fixed, but should be determined by the nature and time of onset of clinical signs and length of the recovery period. The times at which signs of toxicity appear and disappear are important, especially if there is a tendency for signs of toxicity to be delayed. All observations are systematically recorded with individual records being maintained for each animal. Animals found in a moribund condition and animals showing severe pain and/or enduring signs of severe distress should be humanely killed for animal welfare reasons. Care should be taken when conducting examinations for clinical signs of toxicity that initial poor appearance and transient respiratory changes, resulting from the exposure procedure, are not mistaken for treatment-related effects. The principles and criteria summarised in the Humane Endpoints Guidance Document should be taken into consideration (7). When animals are killed for humane reasons or found dead, the time of death should be recorded as precisely as possible.

30. Cage-side observations should include changes in the skin and fur, eyes and mucous membranes, and also respiratory, circulatory, autonomic and central nervous systems, and somato-motor activity and behaviour patterns. When possible, any differentiation between local and systemic effects should be noted. Attention should be directed to observations of tremors, convulsions, salivation, diarrhoea, lethargy, sleep and coma. The measurement of rectal temperatures may provide supportive evidence of reflex bradypnea or hypo/hyperthermia related to treatment or confinement.

Body weights

31. Individual animal weights should be recorded once during the acclimatization period, on the day of exposure prior to exposure (day 0) and at least on days 1, 3 and 7 (and weekly thereafter), and at the time of death or euthanasia if exceeding day 1. Body weight is recognised as a critical indicator of toxicity and animals exhibiting a sustained decrement of $\geq 20\%$, compared to pre-study values, should be closely monitored. Surviving animals are weighed and humanely killed at the end of the post-exposure period.

Pathology

32. All test animals, including those which die during the test or are euthanized and removed from the study for animal welfare reasons, should be subjected to gross necropsy. If necropsy cannot be performed immediately after a dead animal is discovered, the animal should be refrigerated (not frozen) at temperatures low enough to minimize autolysis. Necropsies should be performed as soon as possible, normally within a day or two. All gross pathological changes should be recorded for each animal with particular attention to any changes in the respiratory tract.

33. Additional examinations included *a priori* by design may be considered to extend the interpretive value of the study, such as measuring lung weight of surviving rats and/or providing

evidence of irritation by microscope examination of the respiratory tract. Examined organs may include those showing evidence of gross pathology in animals surviving 24 or more hours, and organs known or expected to be affected. Microscopic examination of the entire respiratory tract may provide useful information for test articles that are reactive with water, such as acids and hygroscopic test articles.

DATA AND REPORTING

Data

34. Individual animal data on body weights and necropsy findings should be provided. Clinical observation data should be summarized in tabular form, showing for each test group the number of animals used, the number of animals displaying specific signs of toxicity, the number of animals found dead during the test or killed for humane reasons, time of death of individual animals, a description and time course of toxic effects and reversibility, and necropsy findings.

Test report

35. The test report should include the following information, as appropriate:

Test animals and husbandry

- Description of caging conditions, including: number (or change in number) of animals per cage, bedding material, ambient temperature and relative humidity, photoperiod, and identification of diet;
- Species/strain used and justification for using a species other than the rat;
- Number, age, and sex of animals;
- Method of randomization;
- Details of food and water quality (including diet type/source, water source);
- Description of any pre-test conditioning including diet, quarantine, and treatment for disease;

Test article

- Physical nature, purity, and, where relevant, physico-chemical properties (including isomerization);
- Identification data and Chemical Abstract Services (CAS) Registry Number, if known;

Vehicle

- Justification for use of vehicle and justification for choice of vehicle (if other than water);
- Historical or concurrent data demonstrating that the vehicle does not interfere with the outcome of the study;

Inhalation chamber

- Description of the inhalation chamber including dimensions and volume;
- Source and description of equipment used for the exposure of animals as well as generation of atmosphere;

- Equipment for measuring temperature, humidity, particle-size, and actual concentration;
- Source of air, treatment of air supplied/extracted and system used for conditioning;
- Methods used for calibration of equipment to ensure a homogeneous test atmosphere;
- Pressure difference (positive or negative);
- Exposure ports per chamber (nose-only); location of animals in the system (whole-body);
- Temporal homogeneity/stability of test atmosphere;
- Location of temperature and humidity sensors and sampling of test atmosphere in the chamber;
- Air flow rates, air flow rate/exposure port (nose-only), or animal load/chamber (whole-body);
- Information about the equipment used to measure oxygen and carbon dioxide, if applicable;
- Time required to reach inhalation chamber equilibrium (t_{95});
- Number of volume changes per hour;
- Metering devices (if applicable);

Exposure data

- Rationale for target concentration selection in the main study;
- Nominal concentrations (total mass of test article generated into the inhalation chamber divided by the volume of air passed through the chamber);
- Actual test article concentrations collected from the animals' breathing zone; for test mixtures that produce heterogeneous physical forms (gases, vapours, aerosols), each may be analysed separately;
- All air concentrations should be reported in units of mass (*e.g.* mg/L, mg/m³, etc.), units of volume (*e.g.* ppm, ppb) may also be reported parenthetically;
- Particle size distribution, mass median aerodynamic diameter (MMAD), and geometric standard deviation (σ_g), including their methods of calculation. Individual particle size analyses should be reported;

Test conditions

- Details of test article preparation, including details of any procedures used to reduce the particle size of solid materials or to prepare solutions of the test article. In cases where mechanical processes may have altered test article composition, include the results of analyses to verify the composition of the test article;
- A description (preferably including a diagram) of the equipment used to generate the test atmosphere and to expose the animals to the test atmosphere;
- Details of the chemical analytical method used and method validation (including efficiency of recovery of test article from the sampling medium);
- The rationale for the selection of test concentrations;

Results

- Tabulation of chamber temperature, humidity, and airflow;
- Tabulation of chamber nominal and actual concentration data;

- Tabulation of particle size data including analytical sample collection data, particle size distribution, and calculations of the MMAD and σ_g ;
- Tabulation of response data and concentration level for each animal (*i.e.* animals showing signs of toxicity including mortality, nature, severity, and duration of effects);
- Individual body weights of animals collected on study days, date and time of death if prior to scheduled euthanasia; time course of onset of signs of toxicity, and whether these were reversible for each animal;
- Necropsy findings and histopathological findings for each animal, if available;
- The GHS category classification and the LC₅₀ cut-off value;

Discussion and interpretation of results

- Particular emphasis should be made to the description of methods used to meet this Test Guideline's criteria, *e.g.* the limit concentration or the particle size;
- The respirability of particles in light of the overall findings should be addressed, especially if the particle-size criteria could not be met;
- The consistency of methods used to determine nominal and actual concentrations, and the relation of actual concentration to nominal concentration should be included in the overall assessment of the study;
- The likely cause of death and predominant mode of action (systemic versus local) should be addressed;
- An explanation should be provided if there was a need to humanely sacrifice animals in pain or showing signs of severe and enduring distress, based on the criteria in the OECD Guidance Document on Humane Endpoints (7).

LITERATURE

1. OECD (2009), Acute Inhalation Toxicity Testing. OECD Guideline for Testing of Chemicals No. 403, OECD, Paris. Available at: [<http://www.oecd.org/env/testguidelines>]
2. Holzhütter, H-G, Genschow, E., Diener, W., and Schlede, E. (2003), Dermal and Inhalation Acute Toxicity Class Methods: Test Procedures and Biometric Evaluations for the Globally Harmonized Classification System. *Arch. Toxicol.* 77, 243-254.
3. Diener, W., Kayser, D. and Schlede, E. (1997), The Inhalation Acute-Toxic-Class Method; Test Procedures and Biometric Evaluations. *Arch. Toxicol.* 71, 537-549.
4. Diener, W, and Schlede, E. (1999), Acute Toxic Class Methods: Alternatives to LD/LC50 Tests. *ALTEX* 1, 129-134.
5. OECD (2001), Acute Oral Toxicity – Acute Toxic Class Method. OECD Guideline for Testing of Chemicals No. 423, OECD, Paris. Available at: [<http://www.oecd.org/env/testguidelines>]
6. OECD (2009), Report on Biostatistical Performance Assessment of the Draft TG 436 Acute Toxic Class Testing Method for Acute Inhalation Toxicity. Environmental Health and Safety Monograph Series on Testing and Assessment No. 105, OECD, Paris. Available at: [<http://www.oecd.org/env/testguidelines>]
7. OECD (2000), Guidance Document on the Recognition, Assessment and Use of Clinical Signs as Humane Endpoints for Experimental Animals Used in Safety Evaluation. Environmental Health and Safety Monograph Series on Testing and Assessment No. 19. Available at: [<http://www.oecd.org/env/testguidelines>]
8. OECD (2009), Guidance Document on Acute Inhalation Toxicity Testing. Environmental Health and Safety Monograph Series on Testing and Assessment No. 39, OECD, Paris. Available at: [<http://www.oecd.org/env/testguidelines>]
9. UN (2007), United Nations Globally Harmonized System of Classification and Labelling of Chemicals (GHS), ST/SG/AC.10/30, UN New York and Geneva. Available: [http://www.unece.org/trans/danger/publi/ghs/ghs_welcome_e.html]
10. OECD (2004), *In Vitro* Skin Corrosion – Transcutaneous Electrical Resistance Test (TER). OECD Guideline for testing of chemicals No. 430, OECD, Paris. Available at: [<http://www.oecd.org/env/testguidelines>]
11. OECD (2004), *In Vitro* Skin Corrosion – Human Skin Model Test. OECD Guideline for testing of chemicals No. 431, OECD, Paris. Available at: [<http://www.oecd.org/env/testguidelines>]
12. OECD (2005), *In Vitro* Membrane Barrier Test Method for Skin Corrosion. OECD Guideline for testing of chemicals No. 435, OECD, Paris. Available at: [<http://www.oecd.org/env/testguidelines>]
13. Phalen, R.F. (2009), *Inhalation Studies: Foundations and Techniques*. (2nd Edition) Informa Healthcare, New York.

14. SOT (1992), Technical Committee of the Inhalation Specialty Section, Society of Toxicology (SOT). Recommendations for the Conduct of Acute Inhalation Limit Tests. *Fund. Appl. Toxicol.* 18, 321-327.
15. Pauluhn, J. and Thiel, A. (2007), A Simple Approach to Validation of Directed-Flow Nose-Only Inhalation Chambers. *J. Appl. Toxicol.* 27, 160-167.

Annex 1**PROCEDURE TO BE FOLLOWED BY EACH OF THE STARTING CONCENTRATIONS
FOR GASES (ppm/4h)****GENERAL REMARKS**

For each starting concentration, the respective testing schemes as included in this Annex outline the procedure to be followed.

Annex 1 a: Starting concentration is 100 ppm

Annex 1 b: Starting concentration is 500 ppm

Annex 1 c: Starting concentration is 2500 ppm

Annex 1 d: Starting concentration is 20000 ppm

Depending on the number of humanely killed or dead animals, the test procedure follows the indicated arrows.

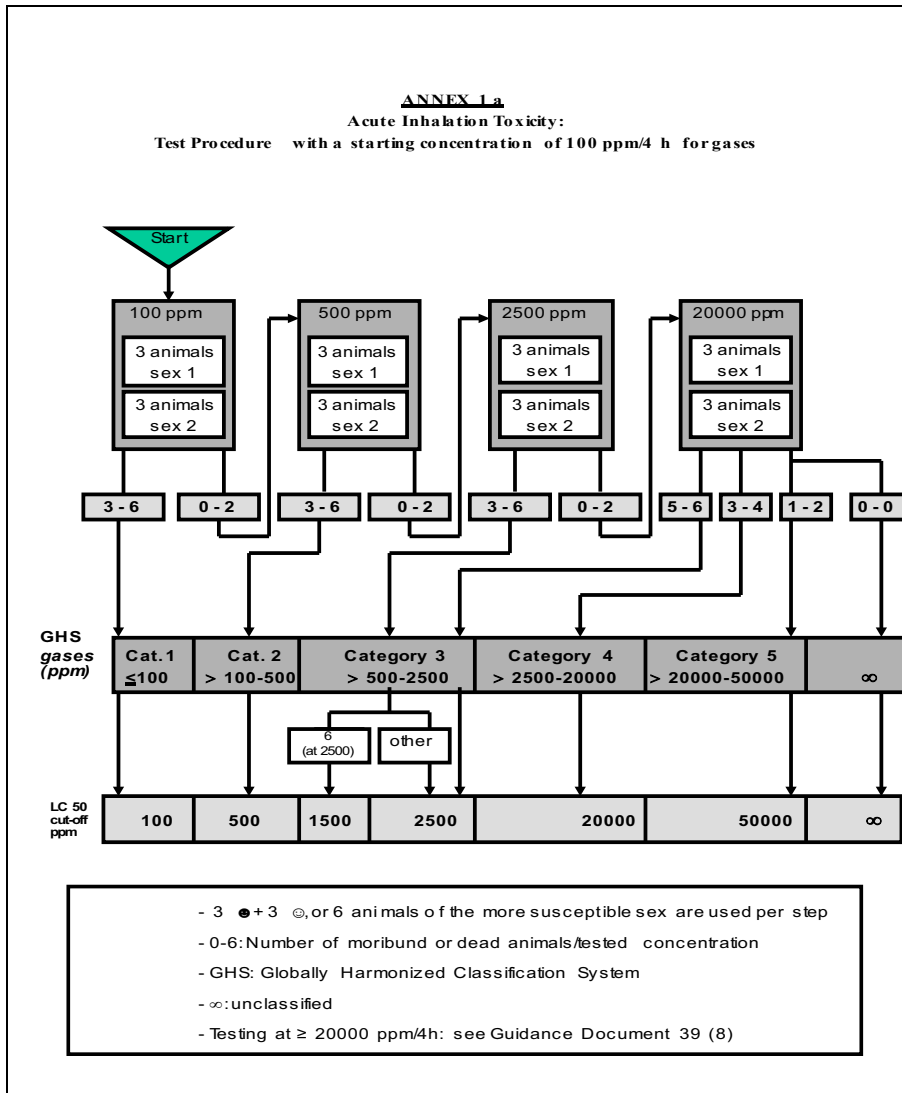

ANNEX 1 b
Acute Inhalation Toxicity:
Test Procedure with a starting concentration of 500 ppm/4h for gases

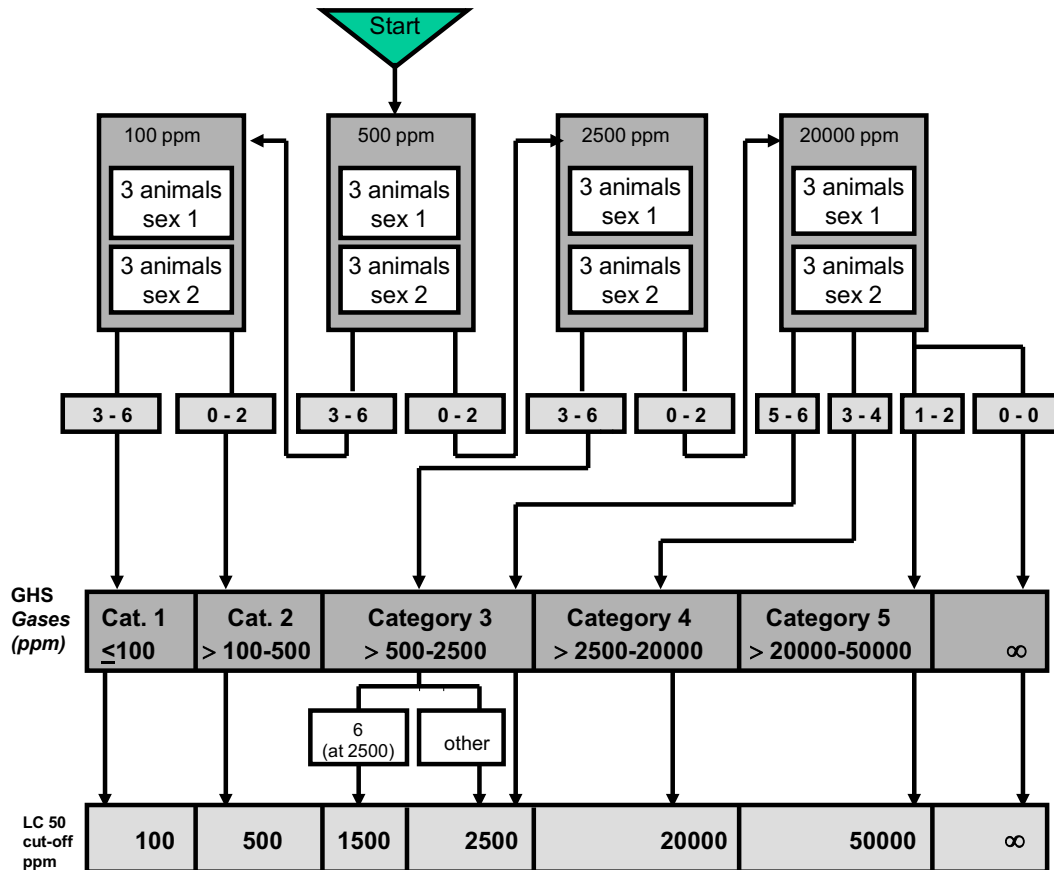

- 3 ♂ + 3 ♀, or 6 animals of the more susceptible sex are used per step
- 0-6: Number of moribund or dead animals/tested concentration
- GHS: Globally Harmonized Classification System
- ∞: unclassified
- Testing at ≥ 20000 ppm/4h: see Guidance Document 39 (8)

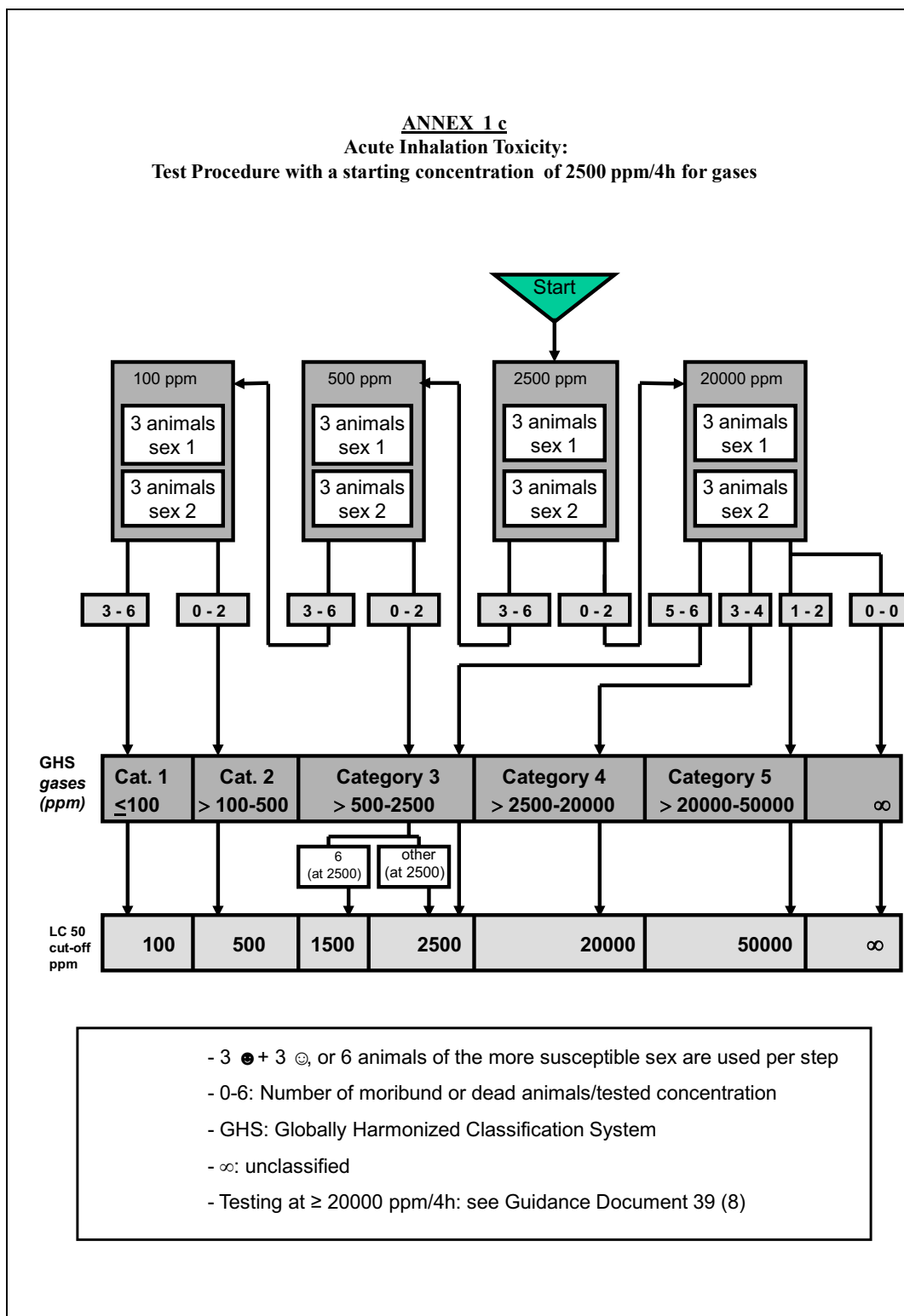

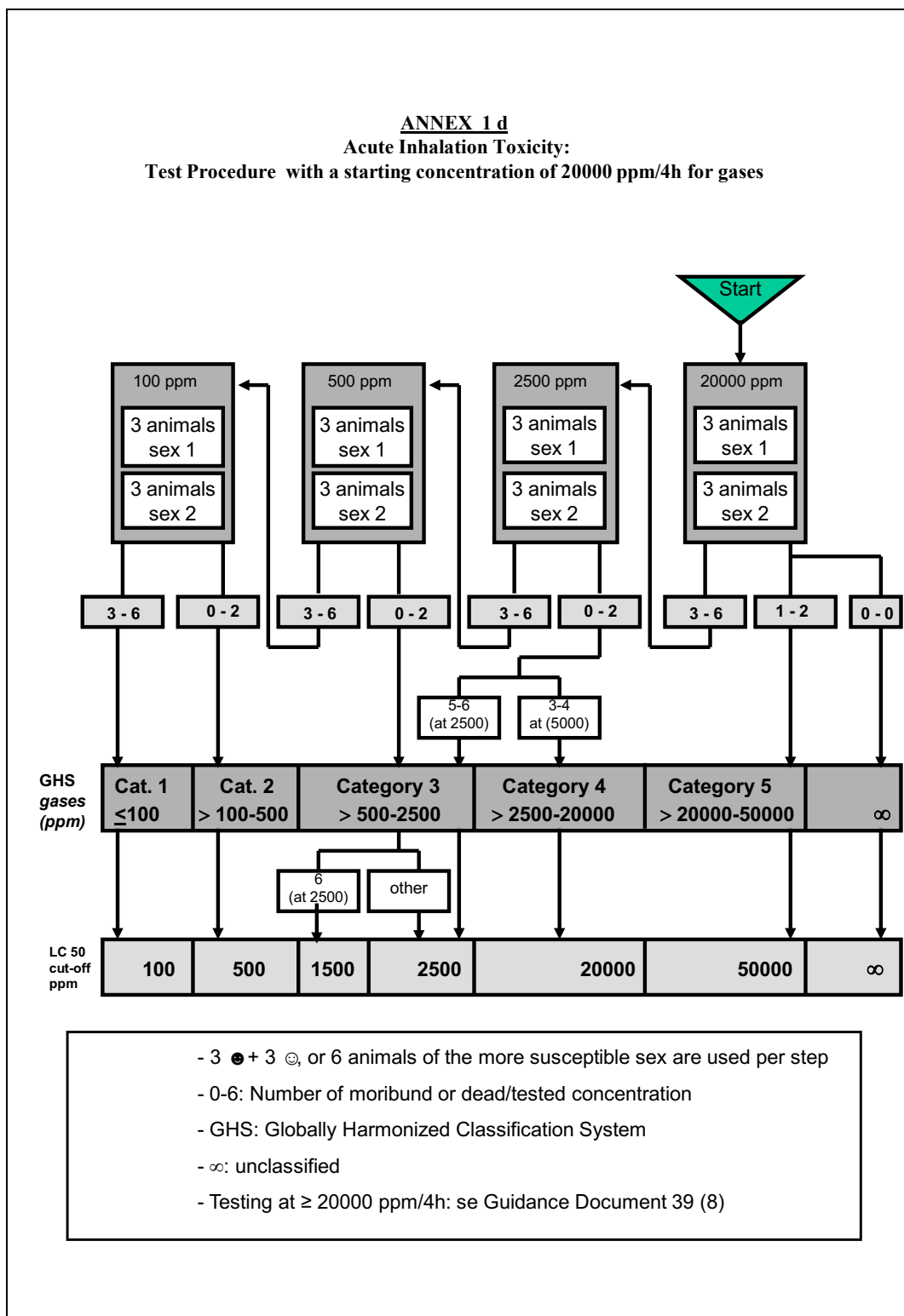

Annex 2**PROCEDURE TO BE FOLLOWED BY EACH OF THE STARTING CONCENTRATIONS
FOR VAPOUR (mg/L/4h)****GENERAL REMARKS**

For each starting concentration, the respective testing schemes as included in this Annex outline the procedure to be followed.

Annex 2 a: Starting concentration is 0.5 mg/L

Annex 2 b: Starting concentration is 2.0 mg/L

Annex 2 c: Starting concentration is 10 mg/L

Annex 2 d: Starting concentration is 20 mg/L

Depending on the number of humanely killed or dead animals, the test procedure follows the indicated arrows.

ANNEX 2 a
Acute Inhalation Toxicity:
Test procedure with a starting concentration of 0.5 mg/L/4h for vapours

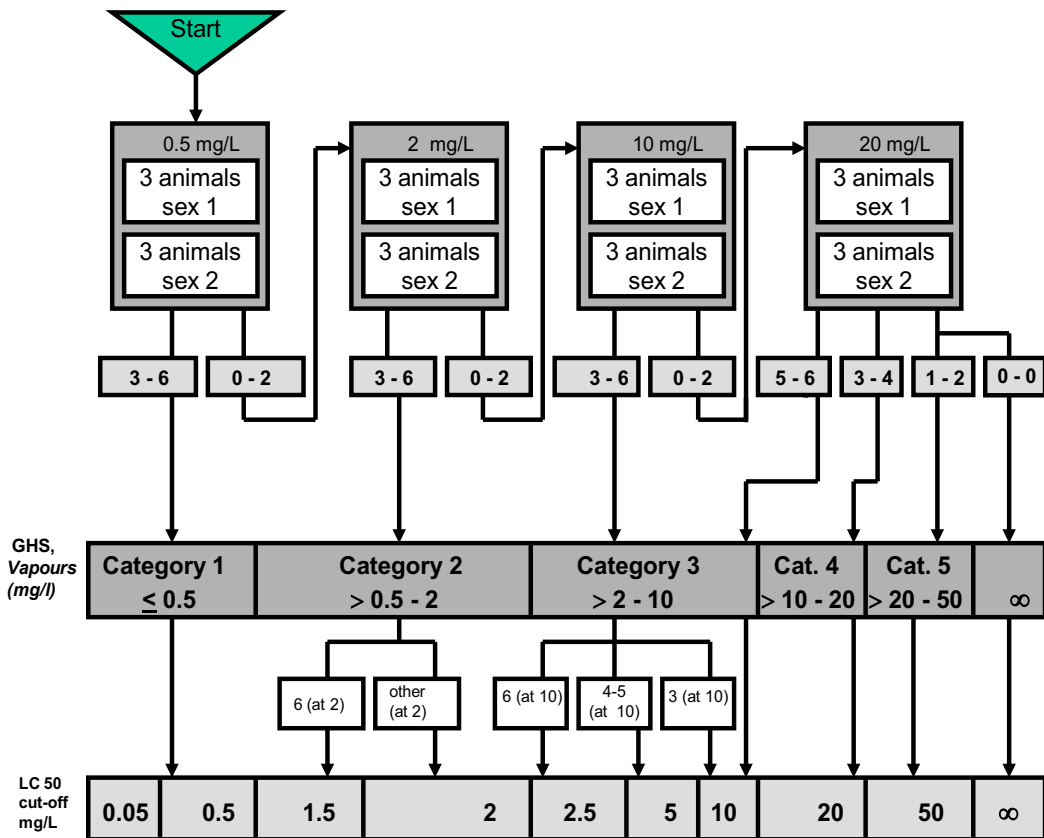

- 3 ♂ + 3 ♀, or 6 animals of the more susceptible sex are used per step
- 0-6: Number of moribund or dead animals/tested concentration
- GHS: Globally Harmonized Classification System
- ∞: unclassified
- Testing at 50 mg/L/4h: see Guidance Document 39 (8)

ANNEX 2 b
Acute Inhalation Toxicity:
Test procedure with a starting concentration of 2 mg/L/4h for vapours

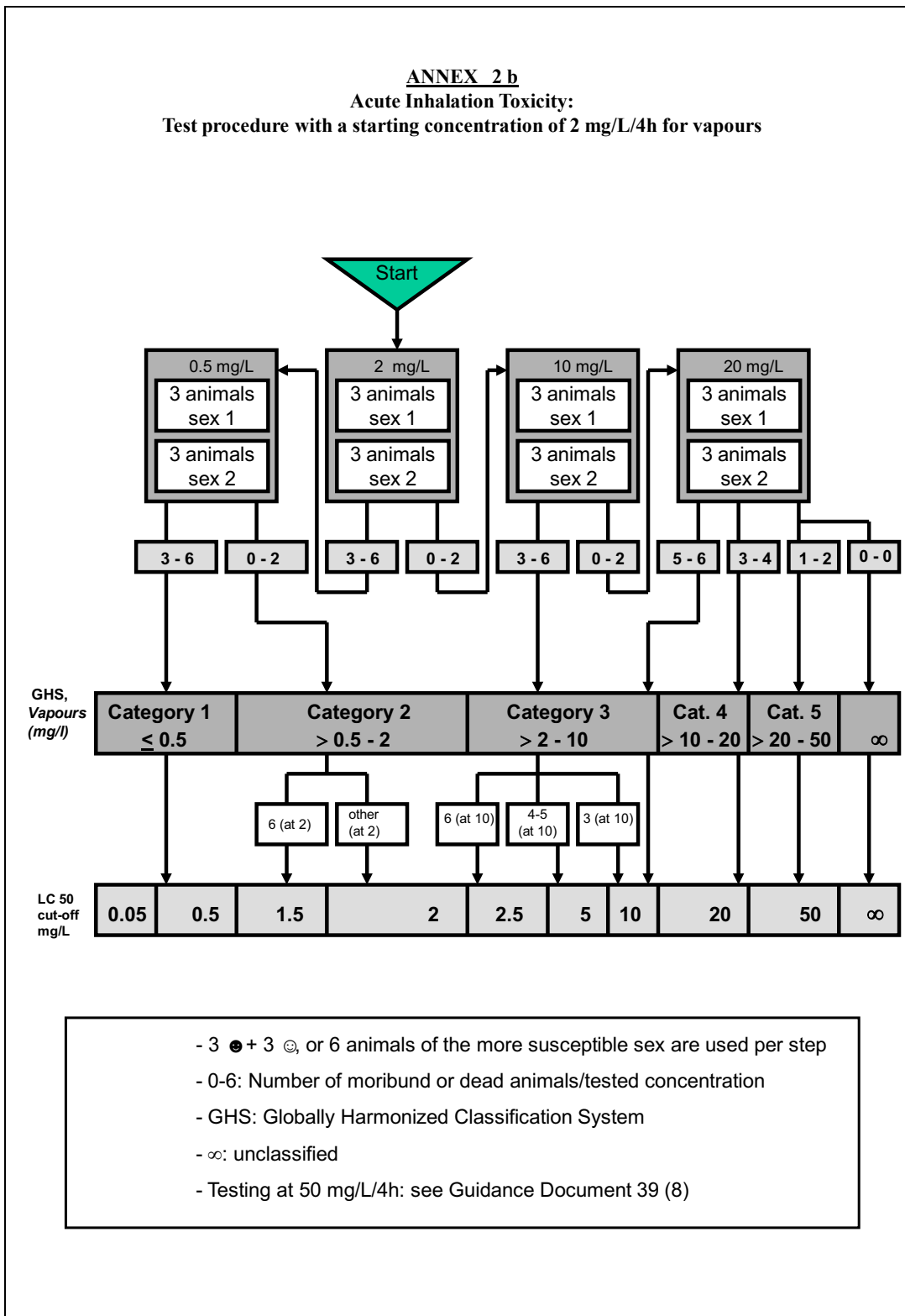

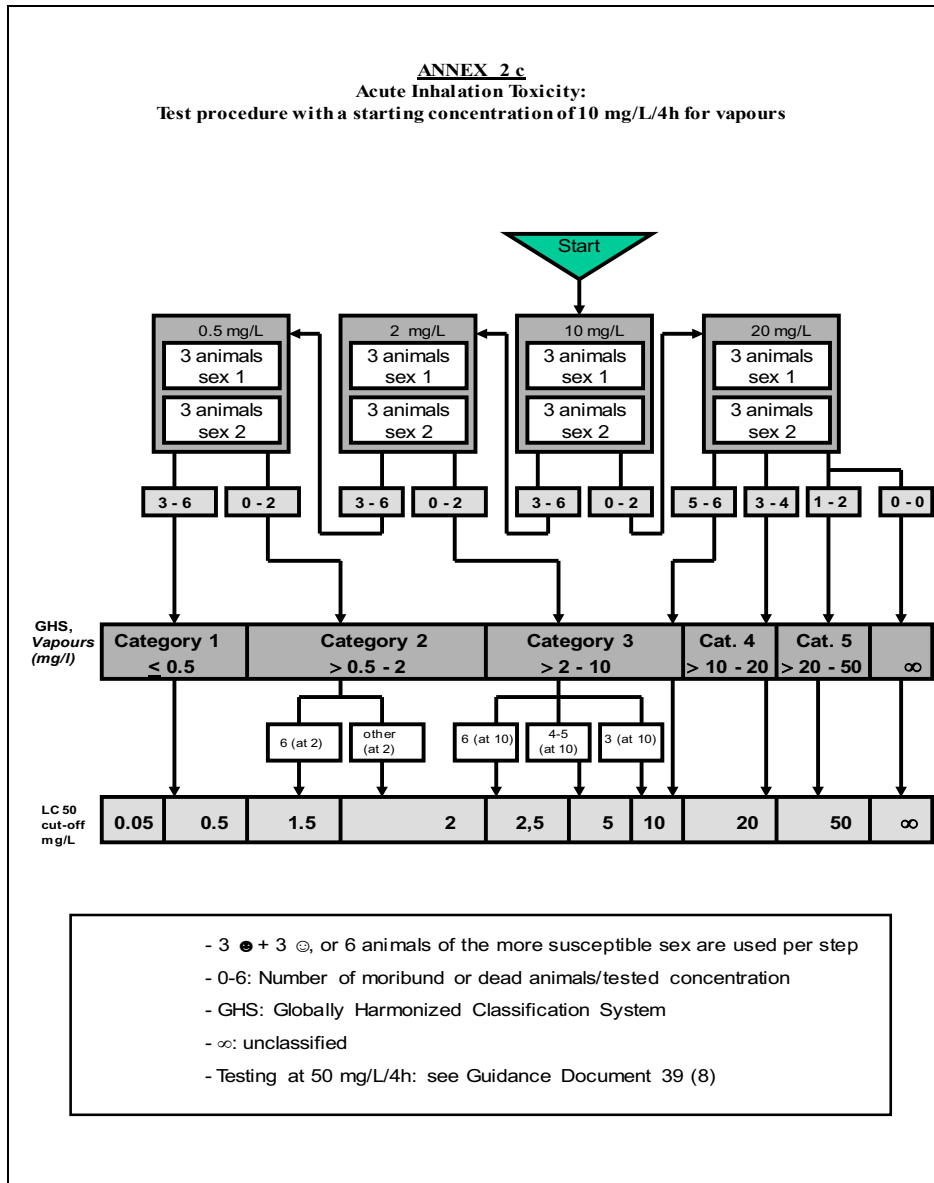

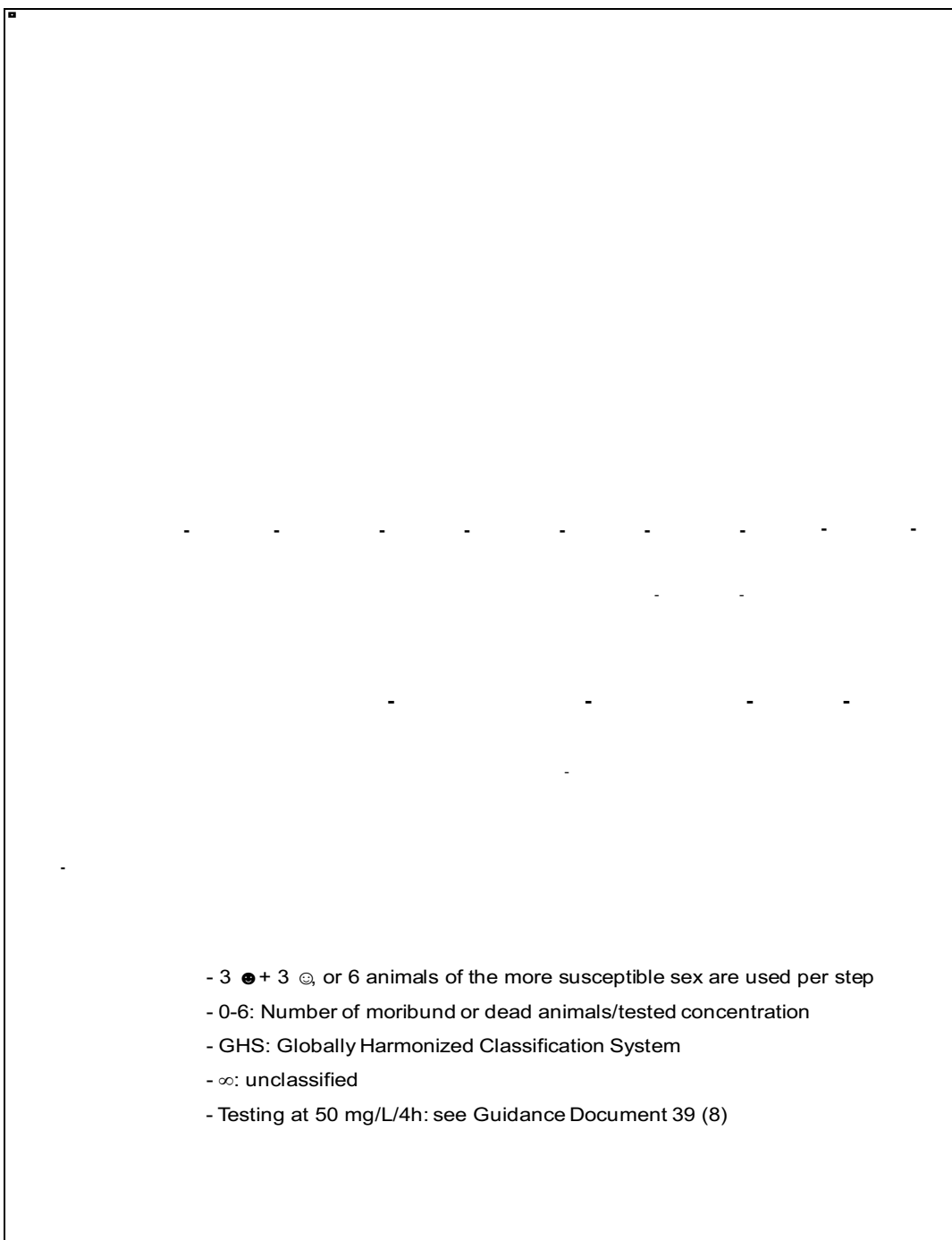

Annex 3**PROCEDURE TO BE FOLLOWED BY EACH OF THE STARTING CONCENTRATIONS
FOR AEROSOLS (mg/L/4h)****GENERAL REMARKS**

For each starting concentration, the respective testing schemes as included in this Annex outline the procedure to be followed.

Annex 3 a: Starting concentration is 0.05 mg/L

Annex 3 b: Starting concentration is 0.5 mg/L

Annex 3 c: Starting concentration is 1 mg/L

Annex 3 d: Starting concentration is 5 mg/L

Depending on the number of humanely killed or dead animals, the test procedure follows the indicated arrows.

ANNEX 3 a
Acute Inhalation Toxicity:
Test procedure with a starting concentration of 0.05 mg/L/4h for aerosols

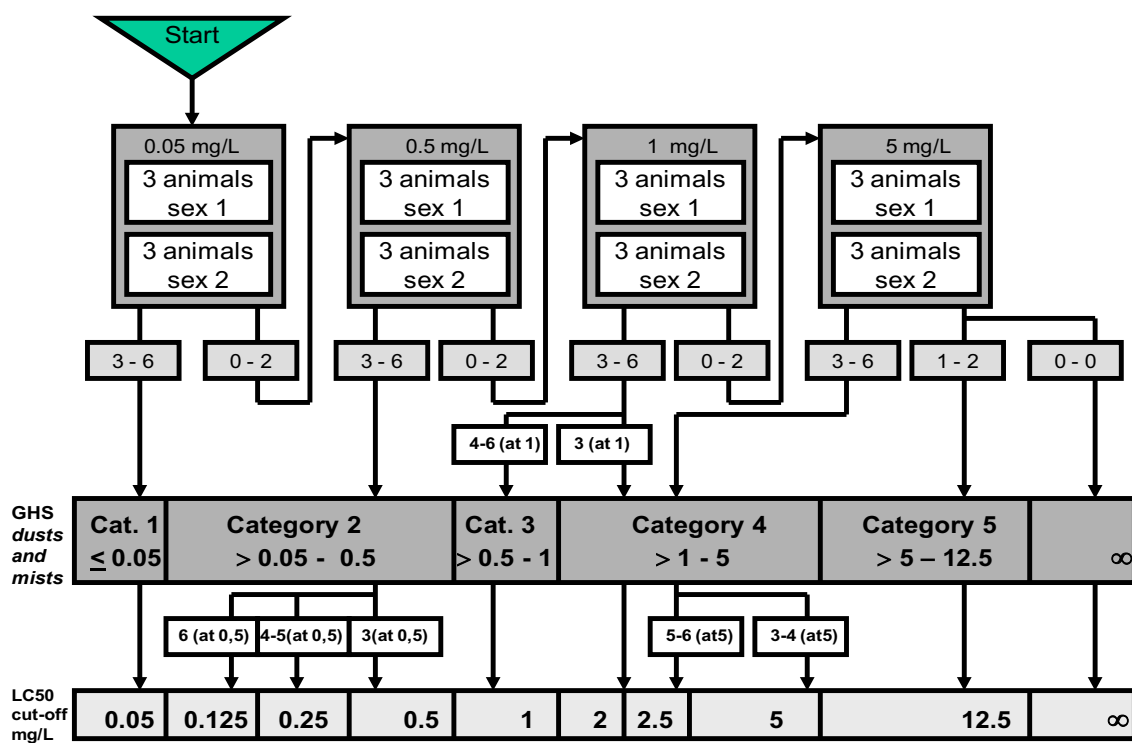

- 3 ♂ + 3 ♀, or 6 animals of the more susceptible sex are used per step
- 0-6: Number of moribund or dead animals/tested concentration
- GHS: Globally Harmonized Classification System
- ∞: unclassified
- Testing at 12.5 mg/L/4h: see Guidance Document 39 (8)

ANNEX 3 b
Acute Inhalation Toxicity:
Test procedure with a starting concentration of 0.5 mg/L/4h for aerosols

Start

	0.05 mg/L		0.5 mg/L		1 mg/L		5 mg/L			
	3 animals sex 1		3 animals sex 1		3 animals sex 1		3 animals sex 1			
	3 animals sex 2		3 animals sex 2		3 animals sex 2		3 animals sex 2			
	3 - 6	0 - 2	3 - 6	0 - 2	3 - 6	0 - 2	3 - 6	1 - 2	0 - 0	
				4-6 (at 1)	3 (at 1)					
GHS dusts and mists	Cat. 1	Category 2		Cat. 3	Category 4		Category 5		∞	
	≤ 0.05	$> 0.05 - 0.5$		$> 0.5 - 1$	$> 1 - 5$		$> 5 - 12.5$			
		6 (at 0,5)	4-5(at 0,5)	3 (at 0,5)		5-6 (at 5)	3-4 (at 5)			
LC50 cut-off mg/L	0.05	0.125	0.25	0.5	1	2	2.5	5	12.5	∞

- 3 ● + 3 ☉, or 6 animals of the more susceptible sex are used per step
 - 0-6: Number of moribund or dead animals/tested concentration
 - GHS: Globally Harmonized Classification System
 - ∞ : unclassified
 - Testing at 12.5 mg/L/4h: see Guidance Document 39 (8)

ANNEX 3 c
Acute Inhalation Toxicity:
Test procedure with a starting concentration of 1 mg/L/4h for aerosols

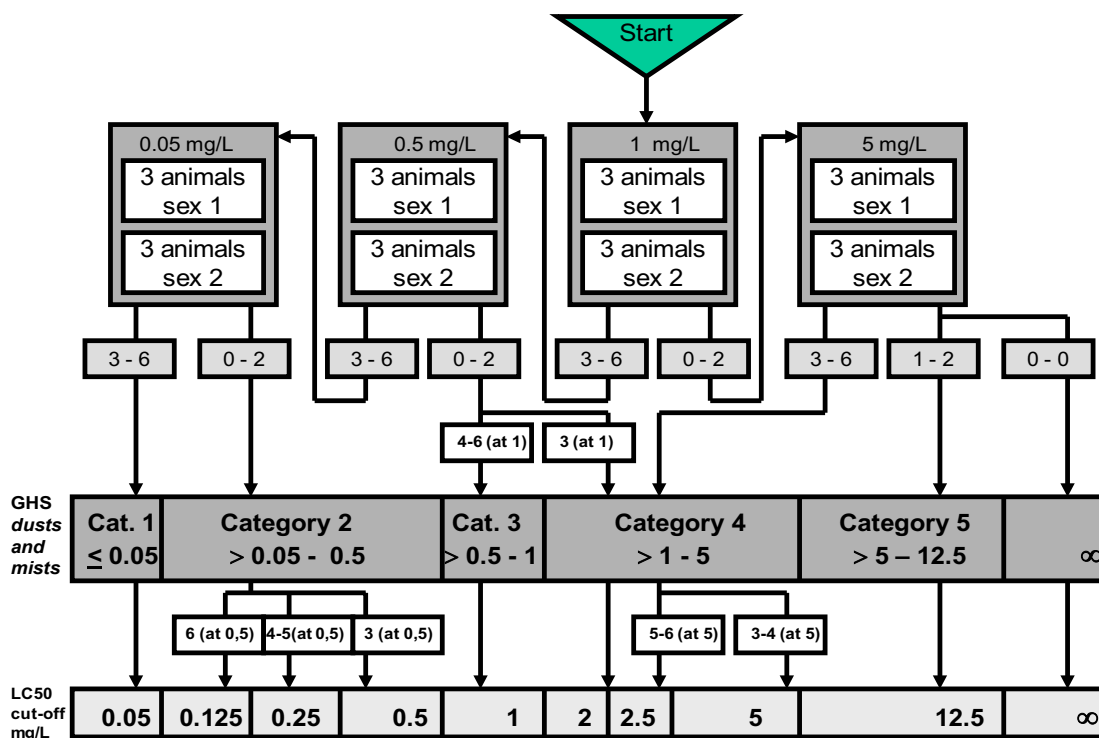

- 3 ♂ + 3 ♀, or 6 animals of the more susceptible sex are used per step
- 0-6: Number of moribund or dead animals/tested concentration
- GHS: Globally Harmonized Classification System
- ∞: unclassified
- Testing at 12.5 mg/L/4h: see Guidance Document 39 (8)

ANNEX 3 d
Acute Inhalation Toxicity:
Test procedure with a starting concentration of 5 mg/L/4h for aerosols

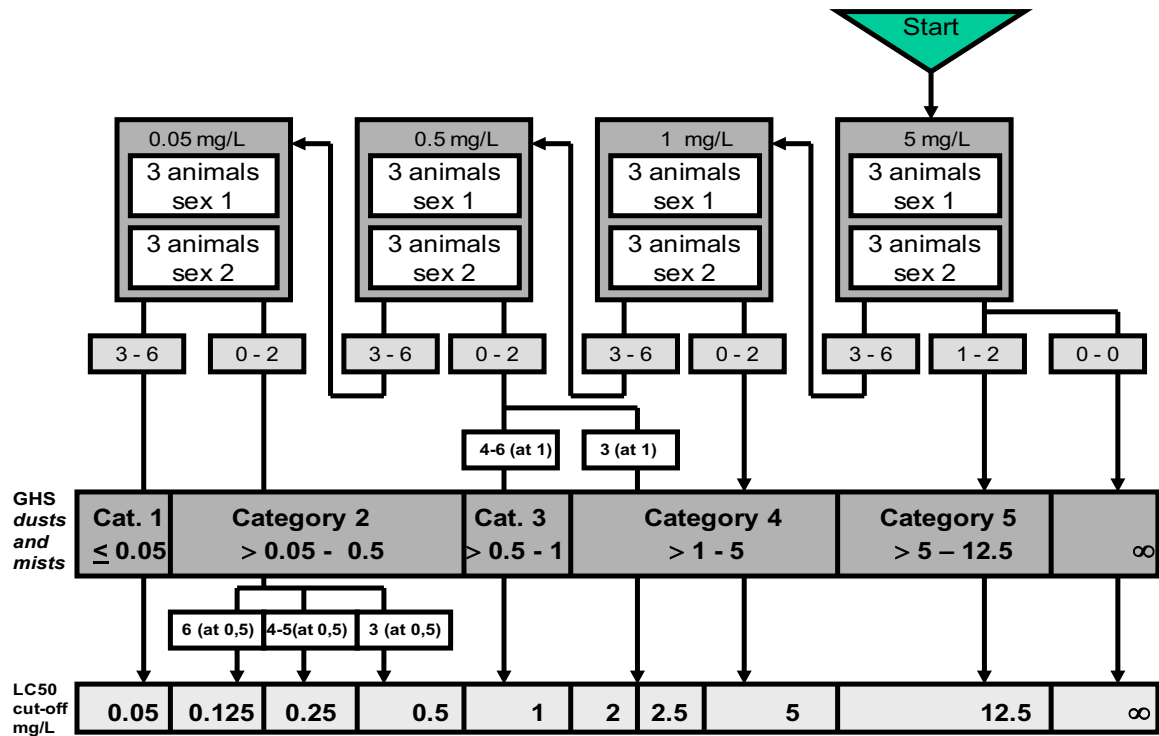

- 3 ♂ + 3 ♀, or 6 animals of the more susceptible sex are used per step
- 0-6: Number of moribund or dead animals/tested concentration
- GHS: Globally Harmonized Classification System
- ∞: unclassified
- Testing at 12.5 mg/L/4h: see Guidance Document 39 (8)